

---

***PNA296***  
***Portable Network***  
***Analyzer***

**Installation and**  
**Operation Manual**

## **LIMITED WARRANTY**

The manufacturer offers the customer a 24-month functional warranty on the instrument for faulty workmanship or parts from date of dispatch from the distributor. In all cases, this warranty is valid for 36 months from the date of production. This warranty is on a return to factory basis.

The manufacturer does not accept liability for any damage caused by instrument malfunction. The manufacturer accepts no responsibility for the suitability of the instrument to the application for which it was purchased.

Failure to install, setup or operate the instrument according to the instructions herein will void the warranty.

Your instrument may be opened only by a duly authorized representative of the manufacturer. The unit should only be opened in a fully anti-static environment. Failure to do so may damage the electronic components and will void the warranty.

## **NOTE**

The greatest care has been taken to manufacture and calibrate your instrument. However, these instructions do not cover all possible contingencies that may arise during installation, operation or maintenance, and not all details and variations of this equipment are covered by these instructions.

For additional information regarding installation, operation or maintenance of this instrument, contact the manufacturer or your local representative or distributor.

---

This manual provides instructions for using the PNA296. For instructions and information on using the PM296 and the accompanying PAS295 software package, you are advised to refer to the relevant user's manuals.

# Table of Contents

<b>1 The Portable Network Analyzer</b>	<b>1</b>
<b>2 Installation</b>	<b>4</b>
2.1 Location	4
2.2 Connecting to the Electrical Network	4
2.3 Wiring Mode Setup	4
2.3.1 Using Standard Current Clamps	5
2.3.2 Using Standard Current Clamps with Special Cables	5
2.4 Current Transformer Setup	6
2.4.1 Direct Measurement (Clamps)	6
2.4.2 Measurement via External CTs (Clamps + Special Cable)	6
2.5 Potential Transformer Setup	7
2.6 Voltage Probes Connection	7
2.7 Current Sensors Connection	7
2.7.1 Standard Clamps	8
2.7.2 Special Cables	8
2.7.3 Standard FLEX Current Sensors	8
<b>3 Power Supply</b>	<b>9</b>
3.1 External Power Supply	9
3.2 Internal Battery Power Supply	9
3.3 Indicators	10
<b>Appendix: Chauvin Arnoux Current Clamps for PNA296</b>	<b>23</b>

## Table of Figures

1-1 Standard Contents of PNA296	2
1-2 Detail of Nos. 8 and 11 in Figure 1-1	3
1-3 Additional Optional Items	3
2-1 3-Wire System Direct Connection	11
2-2 3-Wire System Direct Connection for THD and Harmonic Measurement	12
2-3 4-Wire System Direct Connection	13
2-4 4-Wire Grounded Delta System Direct Connection	14
2-5 3-Wire System Direct Connection, Using Standard Current Clamps with Cables	15
2-6 3-Wire System Direct Connection for THD and Harmonic Measurement, Using Standard Clamps with Cables	16

## **Table of Figures (continued)**

2-7	<i>4-Wire System Direct Connection, Using Standard Clamps with Cables</i> .....	17
2-8	<i>4-Wire Grounded Delta System Direct Connection for THD and Harmonic Measurement, Using Standard Clamps with Cables</i> .....	18
2-9	<i>3-Wire System Connection via External PT and CT, Using Standard Clamps with Cables</i> .....	19
2-10	<i>4-Wire System Connection via External PT and CT, Using Standard Clamps with Cables</i> .....	20
2-11	<i>3-Wire Open Delta 2 ½ Element Connection via 2 External PTs and 3 External CTs, Using Standard Clamps with Cables</i> .....	21
2-12	<i>4-Wire Wye 2 ½ Element Connection via 2 External PTs and 3 External CTs, Using Standard Clamps with Cables</i> .....	22

# 1 The Portable Network Analyzer

The PNA296 Portable Network Analyzer measures, records and analyzes parameters of electrical networks. Being mobile, it enhances efficiency by enabling on-site identification of power problems. The PNA296 meets the requirements of a wide range of applications, from *power quality analysis* to *energy auditing* and *load profile recording* over a period of time.

The PNA296 includes all the **measuring, logging and analyzing capabilities** of the PM296 Power Quality Analyzer in a convenient, portable package. The manufacturer's PAS295 software package included in the PNA296 provides graphic data display and analysis capabilities.

The PNA296 is suitable for direct measurement of voltages up to 660V (or greater when using a Potential Transformer). The PNA296 is equipped with standard clamps with secondary current of 1A. It is also possible to use FLEX sensors with secondary voltage of 3VAC or standard clamps with secondary voltage up to 3VAC.

A unique advantage offered by the PNA296 is its ability to measure small currents, in the range of **100mA to 10A**, in addition to the standard ranges, using **standard high current clamps**, with a high degree of accuracy. This additional measurement capability is made possible by the manufacturer's special cables and electronic circuit used with standard current clamps.

This combination also enables the PNA296 to perform **current measurements on high voltage lines** via current transformers, by measuring the secondary output of the external CT with 5A nominal secondary current.

The PNA296 accuracy is a function of the accuracies of the PM296, the clamps and the external transformers (PT and CT). Most of the PNA296 measurement error is due to the latter two elements.

The PNA296 has an **internal DC battery** which enables it to continue working even when the power supply is disconnected for short intervals, as in a power failure.

The contents of the PNA296 case are shown in *Figures 1-1, 1-2 and 1-3*.

Section 2 of this manual provides installation instructions, including wiring mode, CT and PT setup, as well as connection of voltage probes and current sensors. Section 3 provides information on the internal battery and an explanation of the PNA296 indicator lights.

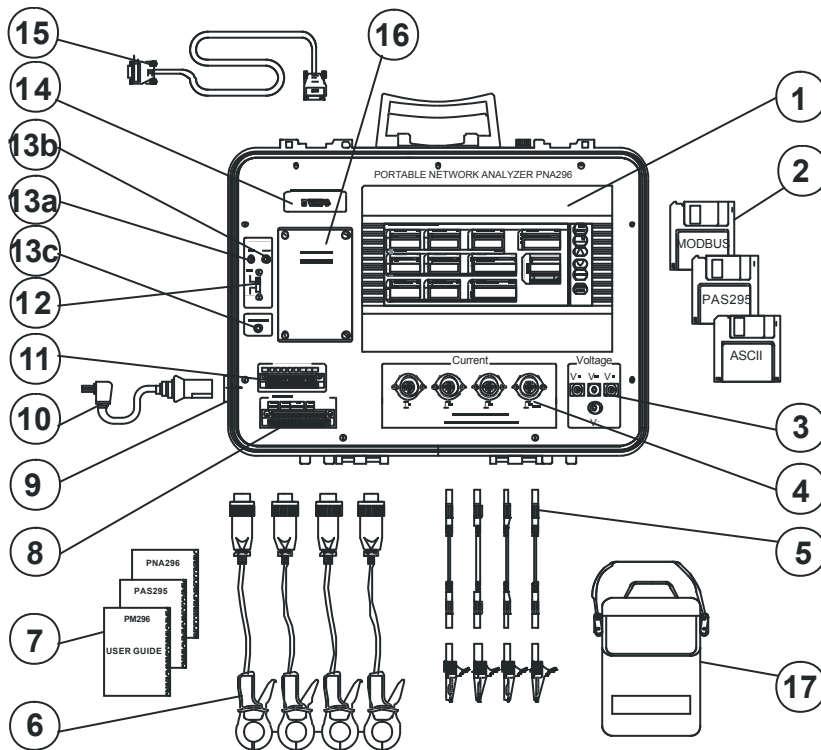

**Figure 1-1 Standard Contents of PNA296**

1	PNA296 Display		
2	PAS295 Software, Modbus and ASCII Reference Guides (diskettes)		
3	Voltage V1, V2, V3, VN inputs - Banana Connections		
4	Current Sensors I1, I2, I3, IAux Inputs - Sockets		
5	Voltage Probe Set (1 black, 3 red, spring-loaded)		
6	Current Clamps Set		
7	Manuals: PNA296, PM296, PAS295		
8	PM296 Relays Connector - see Figure 1-2 for detail		
9	Power Supply Socket & Fuse Housing (100 to 240 VAC)		
10	Power Supply Cord		
11	PM296 Status Inputs Connector - see Figure 1-2 for detail		
12	Slide Switch operating Voltage Supply		
13a	AC Power lamp (green)	13b Battery lamp "BAT" (red)	13c Low battery lamp "BAT LOW" (red, blinking) and buzzer
14	Communication Port (RS-232)		
15	Communication Cable (RS-232)		
16	Battery and Battery Fuse		
17	Case for Clamps and Cables		

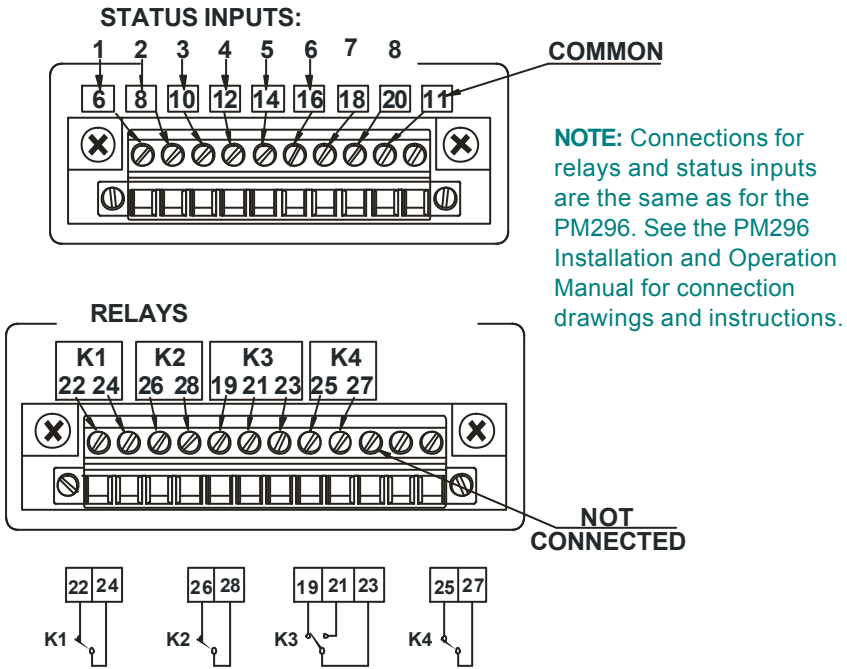

c00-12008-2

**Figure 1-2 Detail of Nos. 8 and 11 in Figure 1-1**

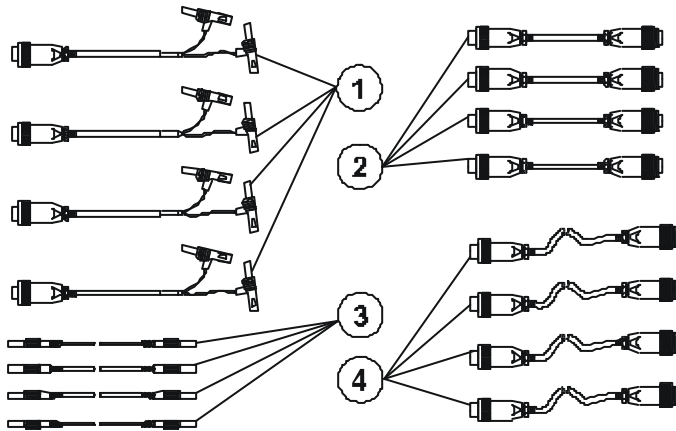

**Figure 1-3 Additional Optional Items**

- 1 Connection Cables for FLEX Current Sensors and for Clamps with voltage output
- 2 Special Cables for Current Clamps for low current measurement (100mA-10A)

## 2 Installation

**Read through this section carefully before connecting the PNA296 to the circuit being tested.**

### 2.1 Location

Place the PNA296 at least half a meter (1.6 feet) from current lines carrying up to 600A, and at least one meter (3.3 feet) for currents between 600A and 2000A.

### 2.2 Connecting to the Electrical Network

Connect the PNA296 to the AC power supply using the Power Supply Cord (No. 10 in Figure 1-1). Turn the slide switch (No. 12 in Figure 1-1) ON.

### 2.3 Wiring Mode Setup

Set the wiring mode on the PM296. Select one of the following seven wiring configurations.

For setup of the wiring mode directly on the PM296 front panel, refer to Table 4-1 of the *PM296 User's Guide*.

For setup of the wiring mode using the PAS295 software, refer to section 4.2.1 of the *PAS295 User's Guide*.

Wiring Configuration	'Wiring Mode'
3-wire direct connection using 2 CTs (2-element)	3dir
3-wire open delta connection using 2 PTs and 2 CTs (2-element)	3OP2
3-wire open delta connection using 2 PTs and 3 CTs (2½-element)	3OP3
4-wire Wye direct connection using 3 CTs (3-element)	4LL3 or 4Ln3
4-wire delta direct connection using 3 CTs (3-element)	4LL3 or 4Ln3
4-wire Wye connection using 3 PTs and 3 CTs (3-element)	4LL3 or 4Ln3
4-wire Wye connection using 2 PTs and 3 CTs (2½-element)	3LL3 or 3Ln3

**Note: Even if measuring one phase current only, all current sensors must be connected, to avoid noise or other disturbances.**



### 2.3.1 Using Standard Current Clamps

The following connections are recommended:

<b>Wiring Configuration</b>	<b>Wiring Mode</b>	<b>Drawing</b>
3-wire configuration with direct connection	3dir	Figure 2-1
3-wire system direct connection for THD and harmonic measurements	3dir	Figure 2-2
4-wire system configuration with direct connection	4LL3/4Ln3	Figure 2-3
4-wire delta system direct connection	4LL3/4Ln3	Figure 2-4

Note: The same connections apply when using FLEX sensors.

### 2.3.2 Using Standard Current Clamps with Special Cables

The following connections are recommended:

<b>Wiring Configuration</b>	<b>Wiring Mode</b>	<b>Figure</b>
3-wire configuration with direct connection	3dir	Figure 2-5
3-wire system direct connection for THD and harmonic measurements	3dir	Figure 2-6
4-wire system configuration with direct connection	4LL3/4Ln3	Figure 2-7
4-wire delta system direct connection	4LL3/4Ln3	Figure 2-8
3-wire system connection via external PT and CT	3OP2	Figure 2-9
4-wire system connection via external PT and CT	4LL3/4Ln3	Figure 2-10
3-wire open delta, 2½-element connection using 2 PTs and 3 CTs	3OP3	Figure 2-11
4-wire Wye, 2½-element connection using 2 PTs and 3 CTs	3LL3/3Ln3	Figure 2-12

## 2.4 Current Transformer Setup

Set the CT according to the *PM296 User's Guide* Rev. A1, Table 4-1 or in the *PAS295 User's Guide* Rev. A1, Section 4.2.1.

### 2.4.1 Direct Measurement (Clamps)

All clamps require the CT to be set according to:

$$CT = I_{1ncl} / I_{2ncl}$$

where  $I_{1ncl}$  and  $I_{2ncl}$  are the clamp nominal primary and secondary currents.

Examples: 1)  $I_{1ncl}=1000A$  and  $I_{2ncl}=1A$ ,  $CT=1000$

2)  $I_{1ncl}=1000A$  and  $I_{2ncl}=5A$ ,  $CT=200$

FLEX sensors and clamps with voltage  $V_{2ncl}$  as an output signal with sensitivity  $S = V_{2ncl} / I_{1ncl}$  [V/A], require the CT to be set according to:

$$CT = 6/S$$

Example:  $I_{1ncl}=200A$ ,  $V_{2ncl}=2V$ , [ $S=2V/200A=0.01V/A$ ],

$$CT=6/0.01=600$$

### 2.4.2 Measurement via External CTs (Clamps + Special Cable)

The CT value should be set according to the following formula:

$$CT = (I_p / I_s) \cdot (I_{1ncl} / I_{2ncl}) \cdot 0.005$$

where:

$I_p$  = external Current Transformer primary nominal current

$I_s$  = external Current Transformer secondary nominal current

#### Examples:

1. When measurement is of current without external transformer ( $I_p / I_s=1$ ) via clamp **1000/1**, then

$CT=5$ , but for accuracy measuring must be set  $CT=5000$  and on the instrument display current will be displayed in mA;

2. When measurement is of secondary of current transformer **3000/5** via clamp **1000/1**, then

$$I_p = 3000, I_s = 5, I_c=1000, C.T. = (3000/5) \cdot (1000/1) \cdot 0.005 = 3000.$$

3. When measurement is of secondary of current transformer **5000/1** via clamp **120/0.12**, then

$$I_p = 5000, I_s = 1, C.T. = (5000/1) \cdot (120/0.12) \cdot 0.005 = 25,000.$$

## 2.5 Potential Transformer Setup

Set the PT according to the *PM296 User's Guide* Rev. A1, Section 4.1 or the *PAS295 User's Guide* Rev. A1, Section 4.2.1.

## 2.6 Voltage Probes Connection

Connect the voltage probes to the PNA296 through the voltage connectors marked **V1/V2/V3/VN**. Connect the probes to the line conductors according to the power system configuration. (An optional set of extension cables for the voltage probes may be ordered.).

### **WARNING**

**The voltage between phases V1, V2, V3 should not exceed 660 VAC RMS (900 VAC peak).**

## 2.7 Current Sensors Connection

**Connect the current sensors first to the PNA296 and then to the measured circuit.** The optional set of extension cables, 3 meters in length, can be used with all current sensors.

There is a common connector for all types of current sensors in each phase.

NOTE: The nominal secondary inputs of the current sensors can be 1A or 5V.

### **WARNING**

**All clamps provided with the PNA296 include special protection against overvoltage. If you use clamps *other* than those provided with the PNA296, *do not under any circumstances* disconnect the current clamps from their sockets while the clamps are connected to the electrical wires. This can cause fatal injury and equipment damage.**

### **2.7.1 Standard Clamps**

The PNA296 contains a set of **standard current clamps** with 1A secondary nominal current and primary nominal current according to the order specification (120A / 1000A / 3000A).

Maximum PNA296 measured current is 200% of the nominal current.

All current clamps in the kit have built-in protection against clamp connector disconnection. See the Appendix for a description of the current clamps.

### **2.7.2 Special Cables**

The manufacturer's special cables, together with the standard clamps, enable the PNA296 to perform measurements of **high voltage lines** via current transformers by measuring the secondary output of the external CT with 5A nominal secondary current.

NOTE: Using clamp 1000A via the special cable will yield greater measurement accuracy than using the 120A clamp.

### **2.7.3 Standard FLEX Current Sensors**

The PNA296 can work with all standard FLEX and clamp current sensors which have a voltage output signal  $1 \text{ Volt} / 10^q \text{ A}$ , where  $q$  = any whole number. Maximum measured current is 200% of the nominal current. The PNA296 provides an optional FLEX connector cable for connection to these current sensors.

## 3 Power Supply

### WARNING

Turn the slide switch OFF when not in use.

### 3.1 External Power Supply

The PNA296 external power supply is 100 to 240 VAC, 45 to 65 Hz, 15 VA.

### 3.2 Internal Battery Power Supply

The PNA296 includes a rechargeable battery (12V/1.2Ah DC battery, Yuasa NP1.2-12). When fully charged, the battery allows the PNA296 to work for at least 20 minutes. Do not allow the battery to totally discharge.

#### Battery Storage

Long-term storage of the battery is according to the following:

Storage temperature	+10°C	+20°C	+30°C	+40°C
Time before recharging required, in months	> 18	14	8	5

#### Charging the Battery

There are 3 indications that the battery is fully discharged: a buzzer sound, a blinking LOW BAT lamp, and no display. Apply AC voltage to the PNA296 to recharge the battery. The recommended charge time is 8 hours, which will allow at least 20 minutes of work.

#### ATTENTION

For reconnection to the AC network and charging, turn the instrument slide switch OFF, wait approximately 5 minutes and then turn it ON again.

### 3.3 Indicators

The following table lists the possible indicated conditions:

Green Lamp- "AC"	Red Lamp- "BAT"	Red Lamp- "LOW BAT"	PM296 Display	Meaning
<b>ON</b>	OFF	OFF	<b>ON</b>	PNA296 supplied by external <b>AC</b> power supply; battery is charging slowly
OFF	<b>ON</b>	OFF	<b>ON</b>	PNA296 supplied by internal charged <b>DC</b> battery
OFF	<b>ON</b>	Blinking (buzzer also sounds)	<b>ON</b>	PNA296 supplied by internal <b>DC</b> power supply; battery needs charging and will disconnect automatically within 5 minutes
<b>ON</b>	OFF	OFF	OFF	PNA296 is connected to external <b>AC</b> power supply, slide switch is OFF; battery is charging rapidly

### 3.4 Measuring Battery Voltage

Battery voltage  $V_{bat}$  is displayed in the DC VOLTAGE window on page 3 of the instrument display.

If  $V_{bat} = 12V$ , the battery is at normal operation. If  $V_{bat} = 11V$ , the battery is LOW. If  $V_{bat} = 10.5V$  the battery is discharged and will no longer operate.

## WIRING DIAGRAMS (Figures 2 -1 through 2 -12)

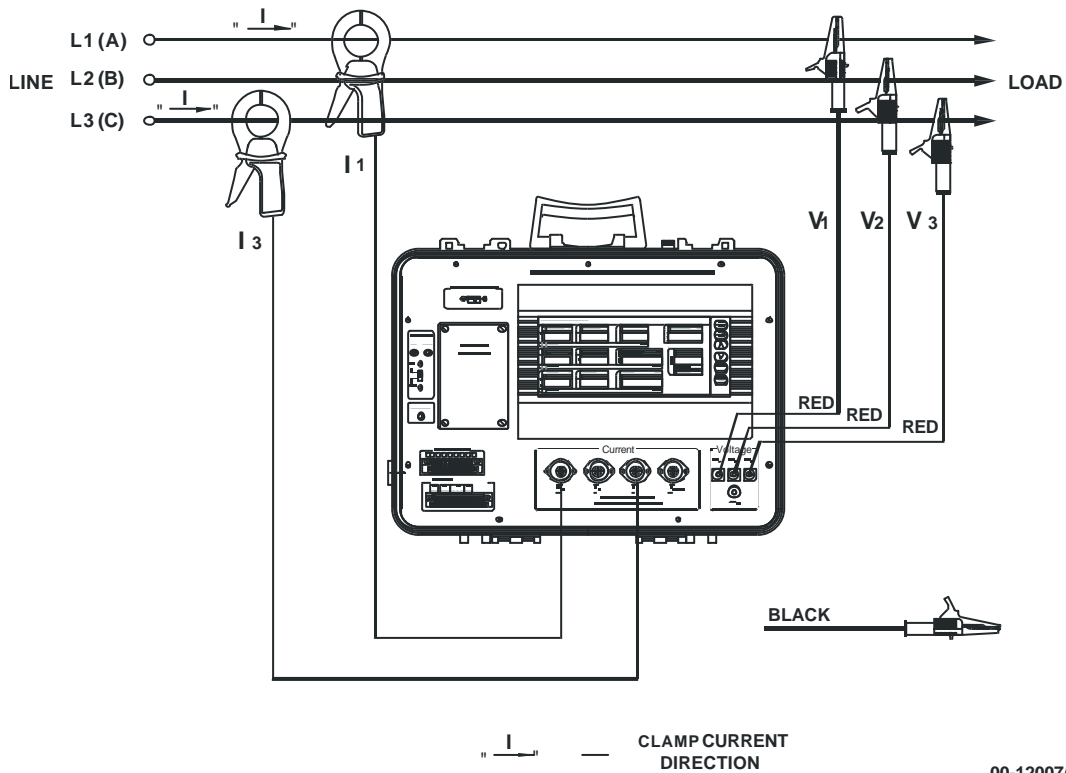

00-12007/2

Figure 2 -1 PNA296 Connections for 3 -Wire System Direct Connection

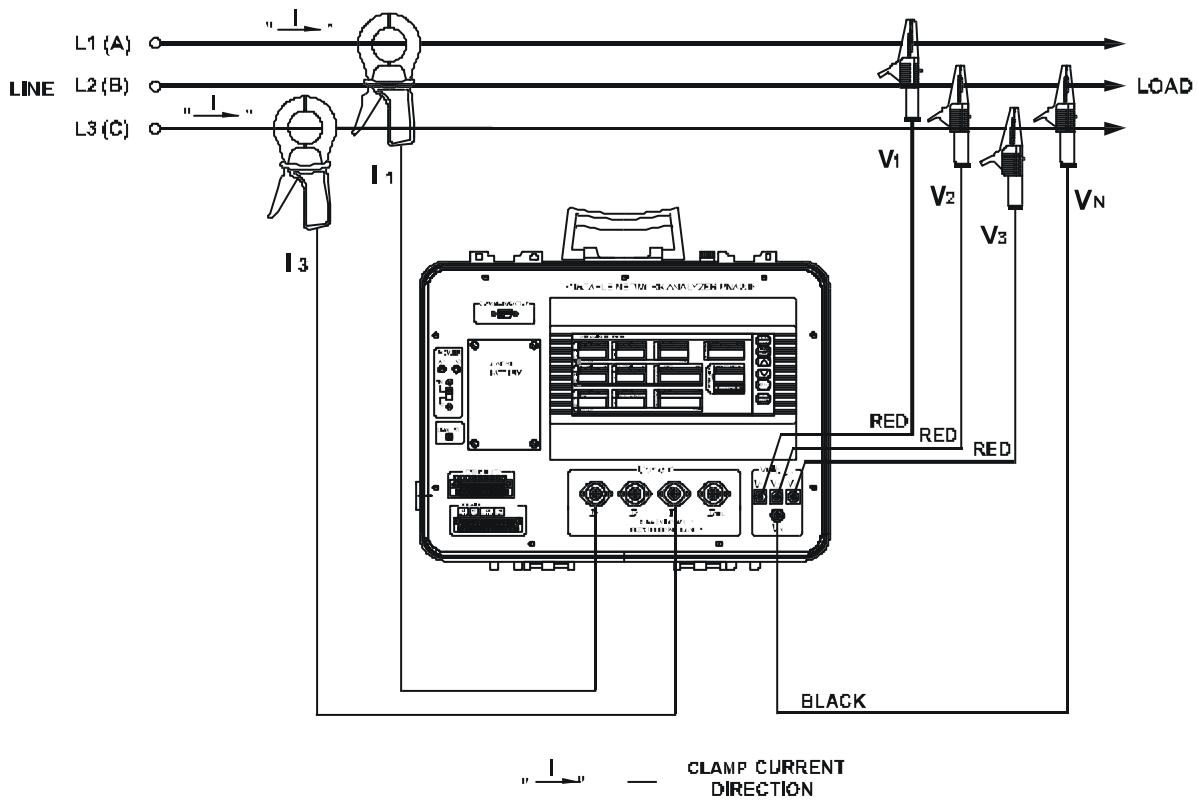

00-12007/3

**Figure 2-2 PNA296 Connections for 3-Wire System Direct Connection for THD and Harmonic Measurement**



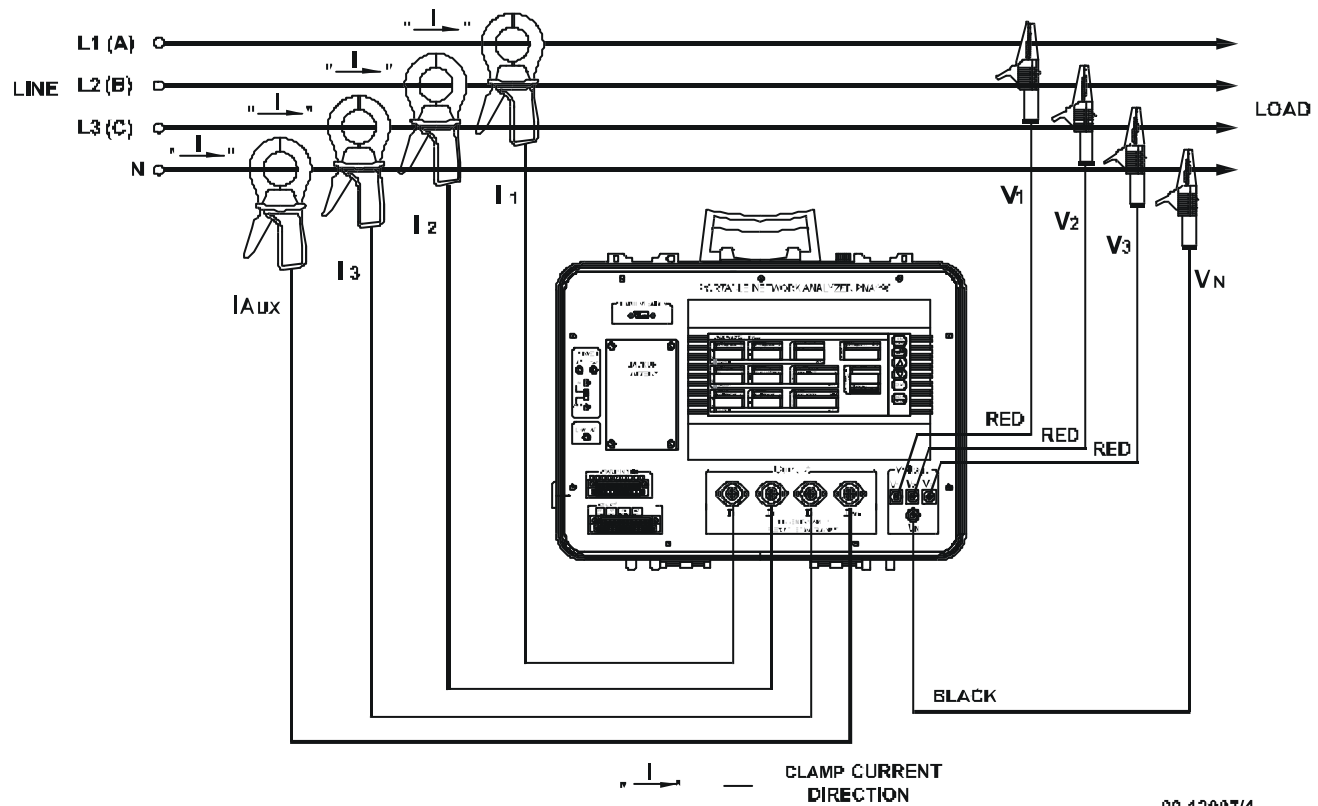

00-12007/4

**Figure 2-3 PNA296 Connections for 4-Wire System Direct Connection**

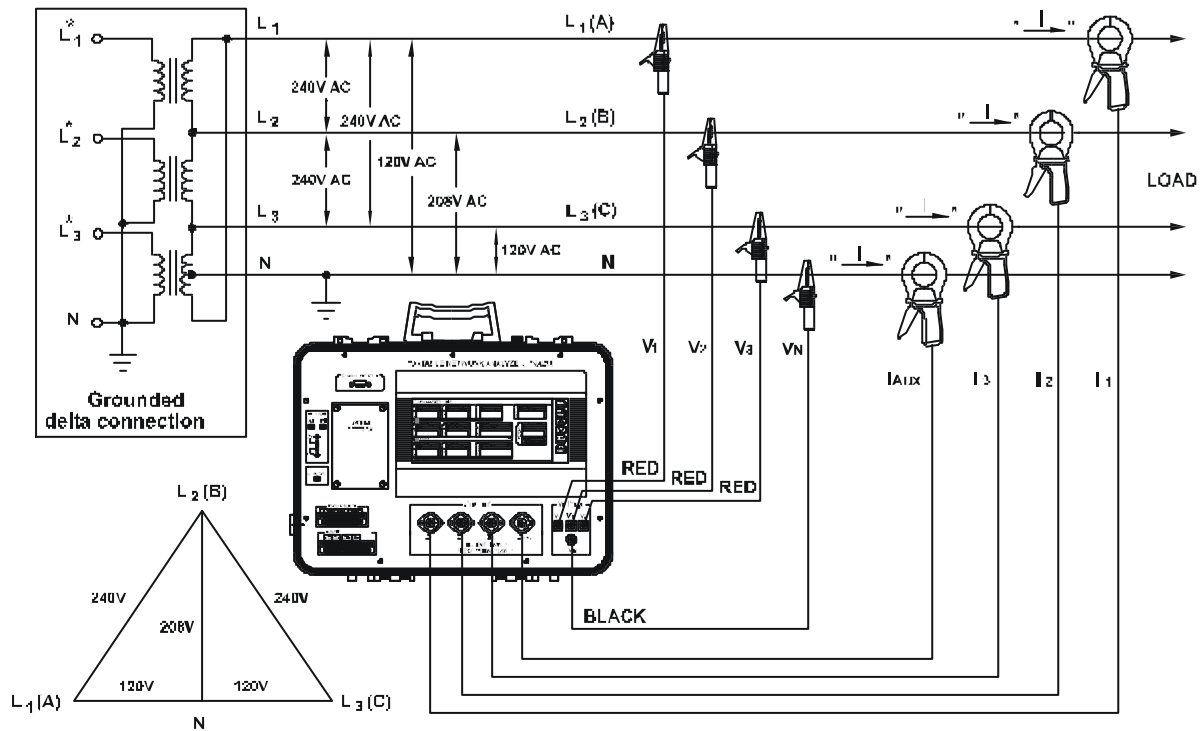

**VOLTAGES DISPLAYED:**

1. Line to neutral voltages: 120V; 208V; 120V.
2. Line to line voltages: 240V.

CLAMP CURRENT DIRECTION

00-12007/5

**Figure 2-4 PNA296 Connections for 4-Wire Grounded Delta System Direct Connection**

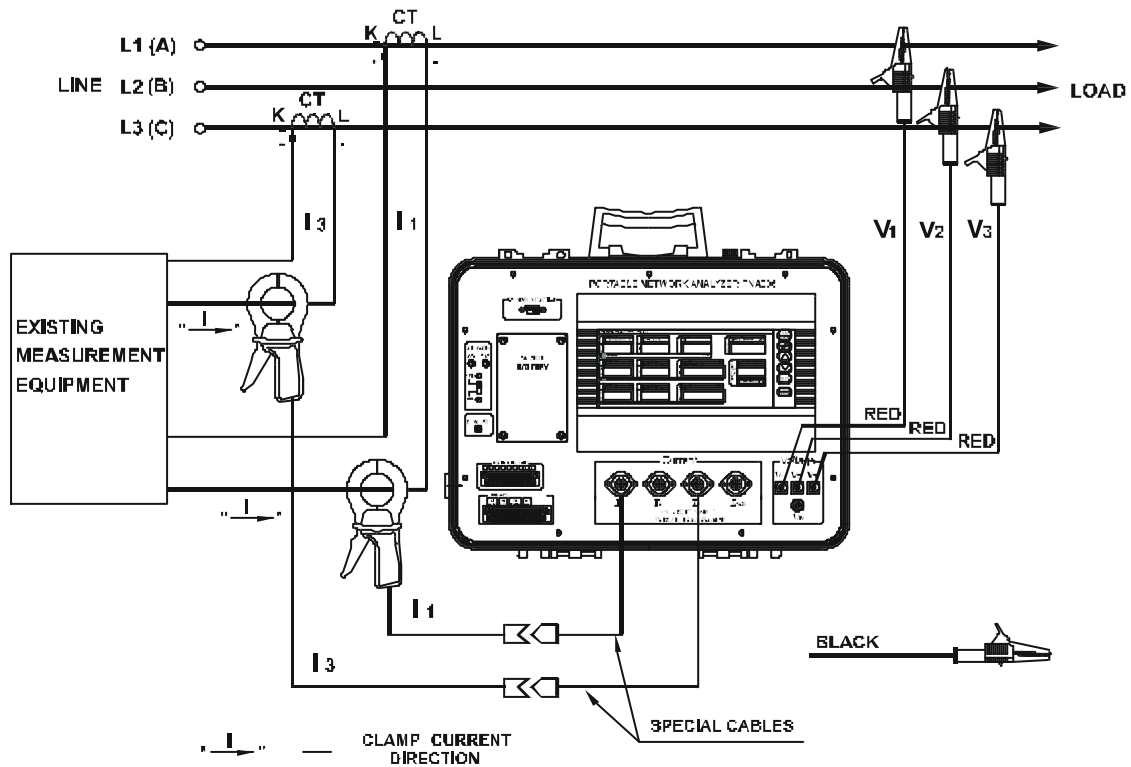

00-12005/1

**Figure 2-5 PNA296 Connections for 3-Wire System Direct Connection, Using Standard Current Clamps with Manufacturer's Special Cables**

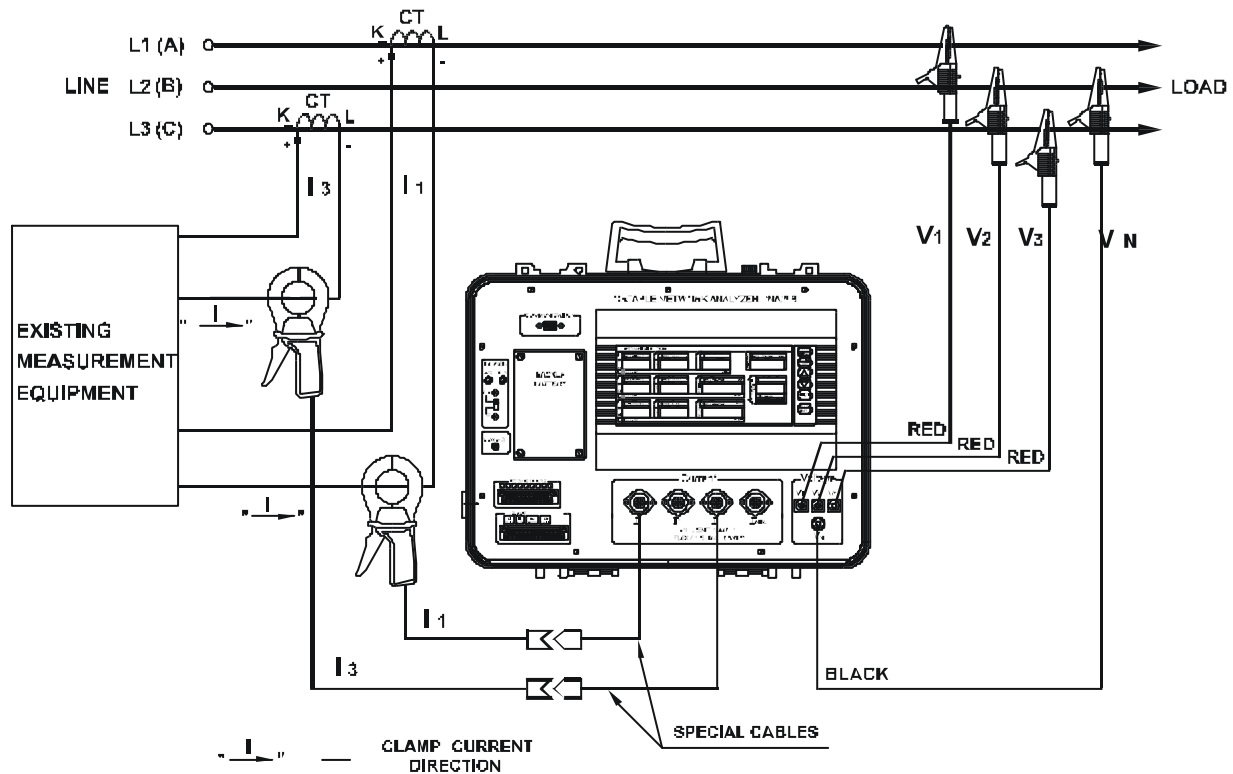

00-12005/2

**Figure 2-6 PNA296 Connections for 3-Wire System Direct Connection for THD and Harmonic Measurement, Using Standard Clamps with Manufacturer's Special Cables**



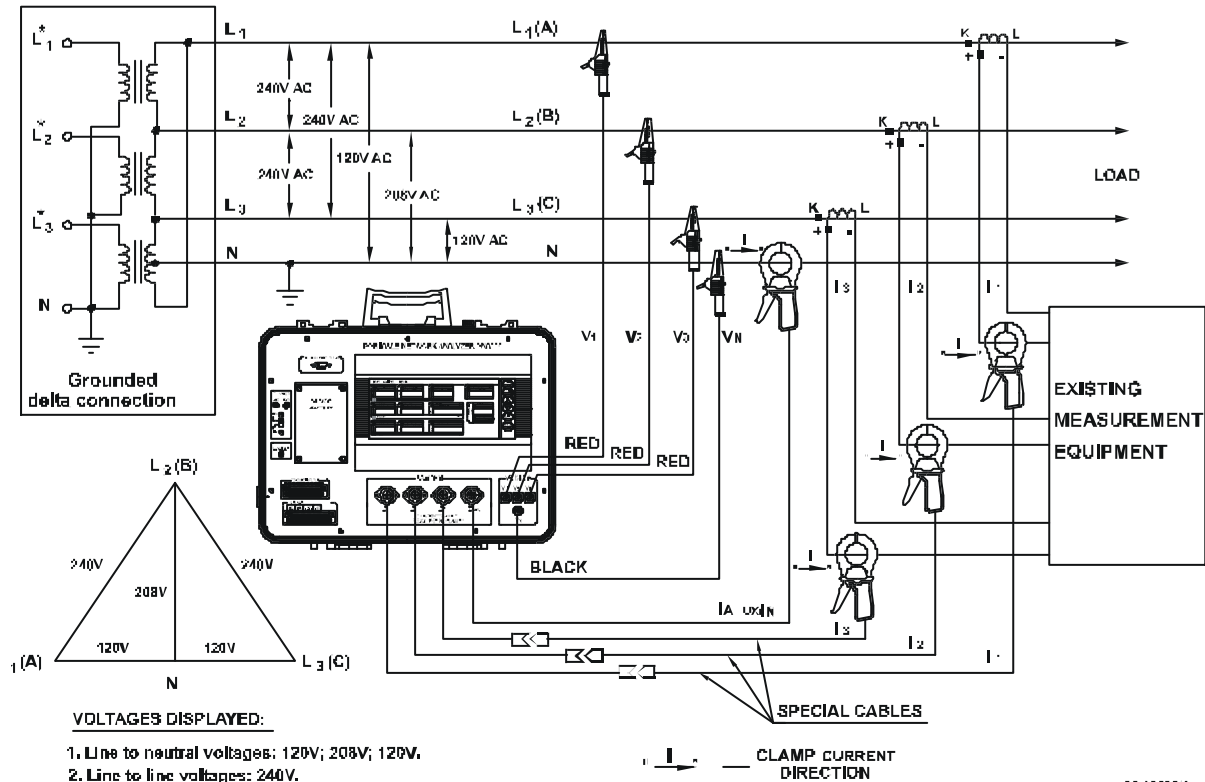

01-12016.4

**Figure 2-8 PNA296 Connections for 4-Wire Grounded Delta System Direct Connection for THD and Harmonic Measurement, Using Standard Clamps with Manufacturer's Special Cables**

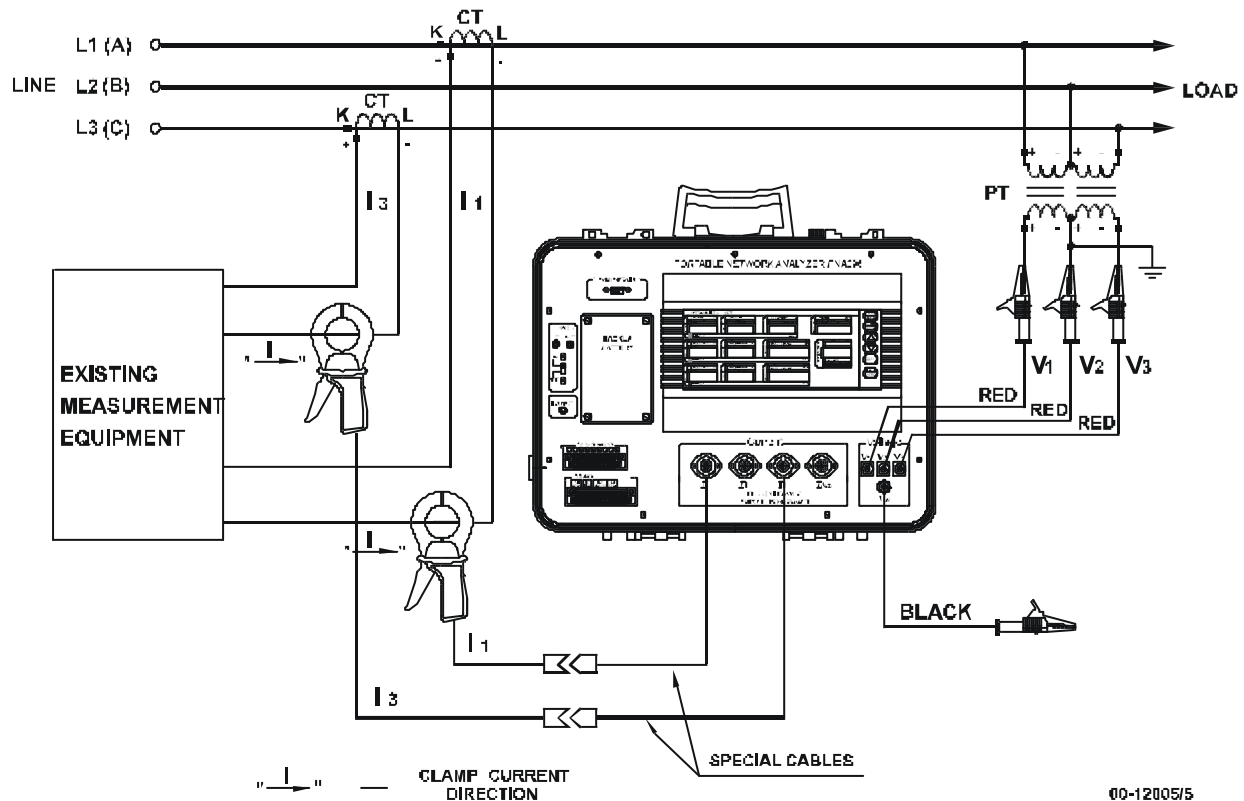

00-12005/5

**Figure 2-9 PNA296 Connections for 3-Wire System Connection via External PT and CT, Using Standard Clamps with Manufacturer's Special Cables**

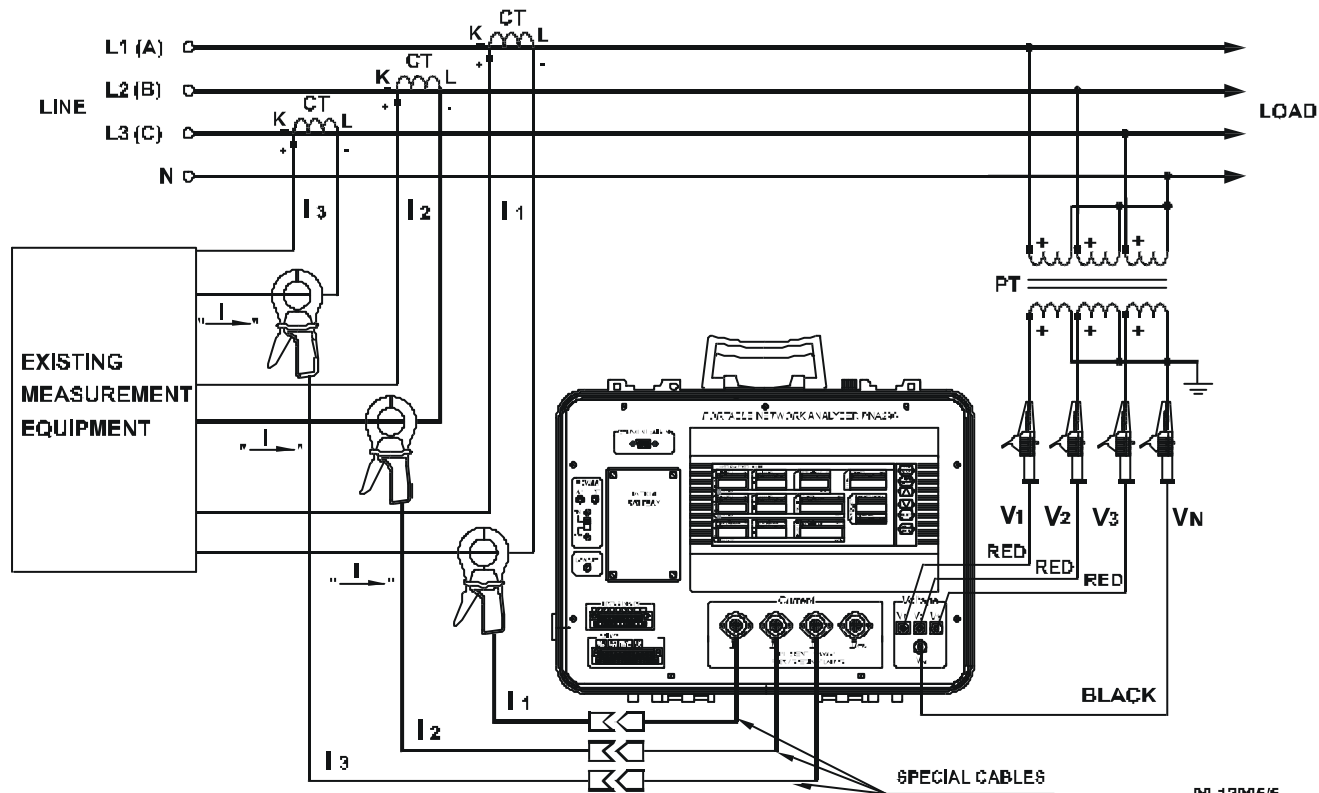

00-12005/6

**Figure 2-10 PNA296 Connections for 4-Wire System Connection via External PT and CT, Using Standard Clamps with Manufacturer's Special Cables**



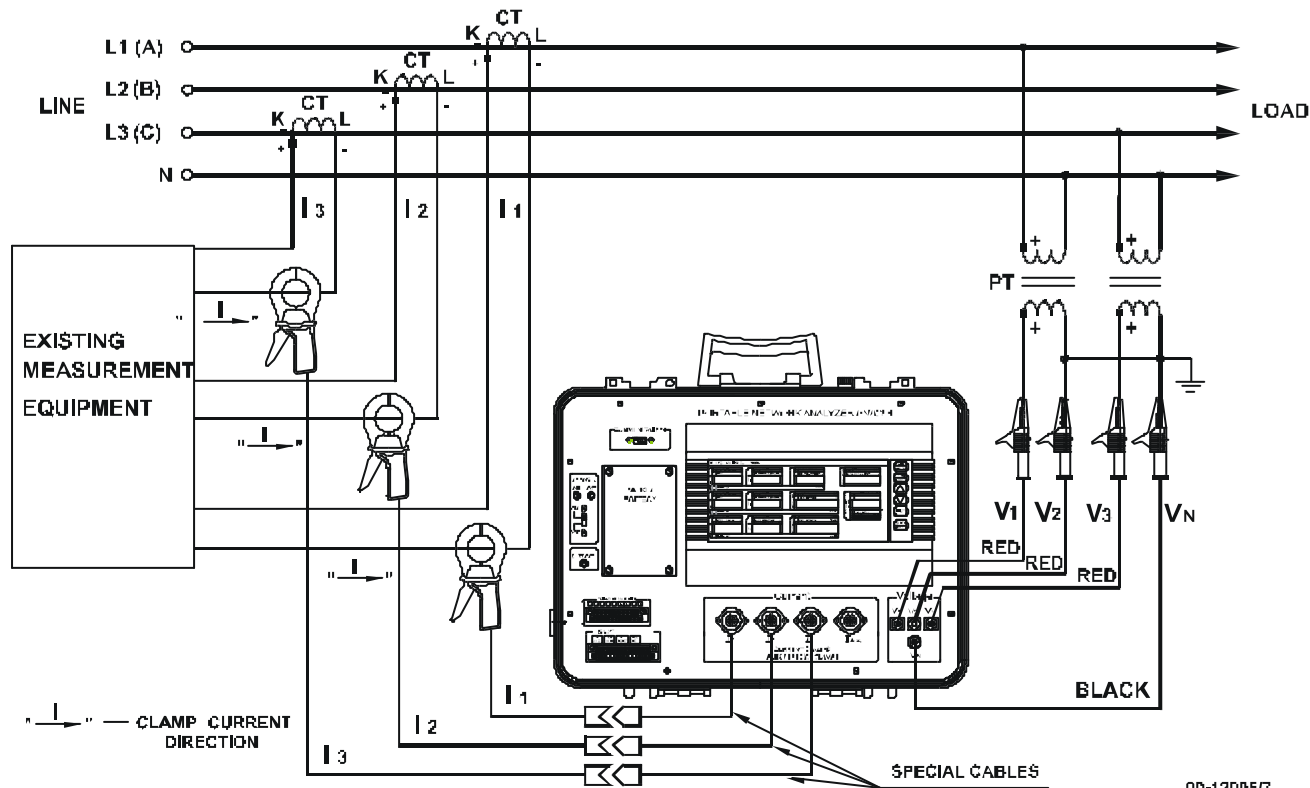

**Figure 2-11 PNA296 Connections for 3-Wire Open Delta 2 1/2 Element Connection via 2 External PTs and 3 External CTs, Using Standard Clamps with Manufacturer's Special Cables**

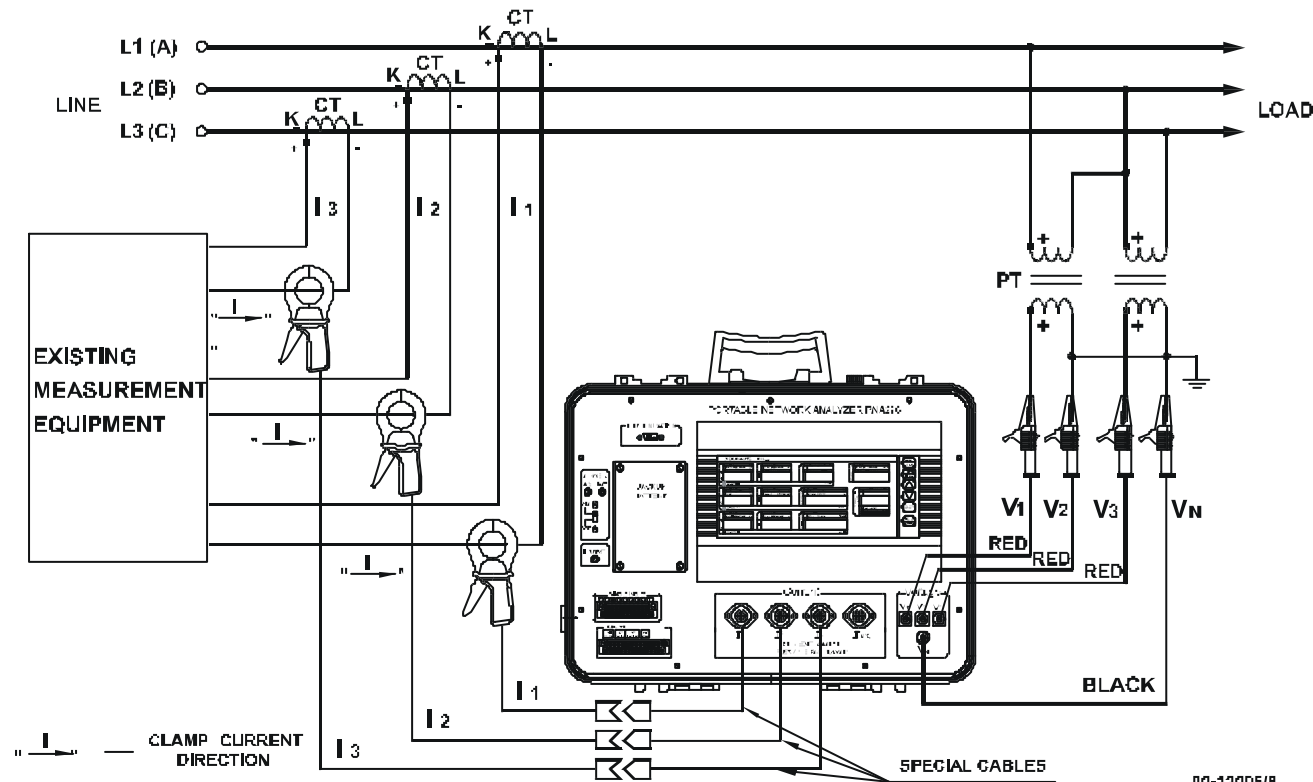

00-12005/B

**Figure 2-12 PNA296 Connections for 4-Wire Wye 2½ Element Connection via 2 External PTs and 3 External CTs, Using Standard Clamps with Manufacturer's Special Cables**

## Appendix: Chauvin Arnoux Current Clamps for PNA296

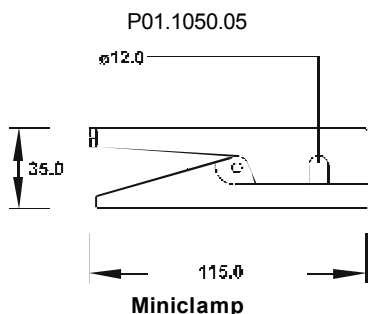
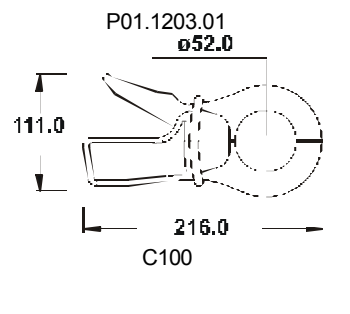
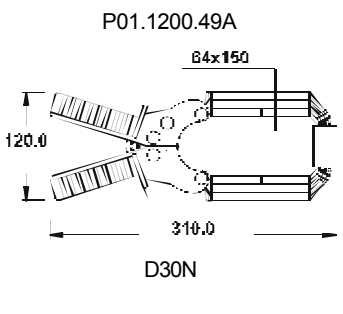
Clamp Model (dimensions in mm)	P01.1050.05  <p style="text-align: center;"><b>Miniclamp</b></p>	P01.1203.01  <p style="text-align: center;"><b>C100</b></p>	P01.1200.49A  <p style="text-align: center;"><b>D30N</b></p>
Direct Utilization	2A-240A RMS    CT <sup>1</sup> = 1000	14-2000A RMS    CT <sup>1</sup> = 1000	42A-6000A RMS    CT <sup>1</sup> = 3000
via Special Cable	0.1A 10A RMS    CT <sup>2</sup> = 5000 (displayed in mA)	0.1-10A RMS    CT <sup>2</sup> = 5000 (displayed in mA)	0.3A-30A RMS    CT <sup>2</sup> = 15000 (displayed in mA)
Transformation Ratio	1000:1	1000:1	3000:1
Working Frequency Hz	30-10KHz	30-5KHz	30-5KHz
Direct Utilization error	1.5%	3%-0.5%	1.5%-0.5%
via Special Cable error	(Additional Special Cable Error = 0.5%)		
Angle Error Degree	3.5°	3° - 0.5°	1.5° - 0.5°
Working Voltage Vrms	30Vmax common mode between output and ground	600	600

<sup>1</sup> See Section 2.4 for CT setup.

<sup>2</sup> a) for direct low current measurement, set CT as shown

b) for primary current measurement via external transformer, set CT as per Section 2.4.2.

